

Three Phase Rectifier Bridge with IGBT and Fast Recovery Diode for Braking System

$V_{RRM} = 1600\text{ V}$
 $I_{dAVM} = 116/145\text{ A}$

V_{RRM} V	Type
1600	VUB 116-16 NO1
1600	VUB 145-16 NO1

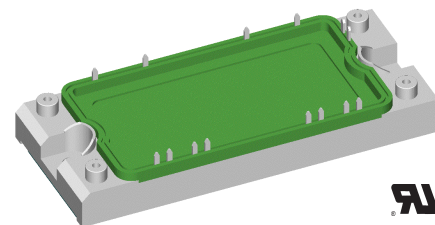
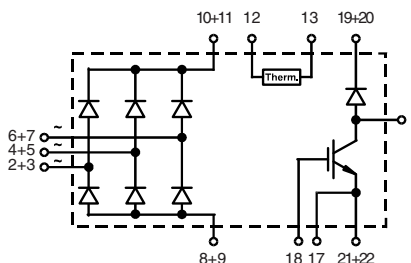

Pin arrangement see outline drawing

Symbol	Conditions	Maximum Ratings	
		VUB 116	VUB 145
V_{RRM}		1600	1600 V
I_{dAVM}		116	145 A
I_{FSM}	$T_{VJ} = 45^\circ\text{C}, t = 10\text{ ms}, V_R = 0\text{ V}$	700	1100 A
	$T_{VJ} = 150^\circ\text{C}, t = 10\text{ ms}, V_R = 0\text{ V}$	610	960 A
I^2t	$T_{VJ} = 45^\circ\text{C}, t = 10\text{ ms}, V_R = 0\text{ V}$	2450	6050 A
	$T_{VJ} = 150^\circ\text{C}, t = 10\text{ ms}, V_R = 0\text{ V}$	1860	4610 A
P_{tot}	$T_C = 25^\circ\text{C}$ per diode	190	250 W
V_{CES}	$T_{VJ} = 25^\circ\text{C}$ to 150°C	1200	1200 V
V_{GE}	Continuous	± 20	± 20 V
I_{C25}	$T_C = 25^\circ\text{C}$, DC	95	141 A
I_{C80}	$T_C = 80^\circ\text{C}$, DC	67	100 A
I_{CM}	$t_p =$ Pulse width limited by T_{VJM}	100	150 A
P_{tot}	$T_C = 25^\circ\text{C}$	380	570 W
V_{RRM}		1200	V
I_{FAV}	$T_C = 80^\circ\text{C}$, rectangular $d = 0.5$	27	A
I_{FRMS}	$T_C = 80^\circ\text{C}$, rectangular $d = 0.5$	38	A
I_{FSM}	$T_{VJ} = 45^\circ\text{C}, t = 10\text{ ms}$	200	A
P_{tot}	$T_C = 25^\circ\text{C}$	130	W
T_{VJ}	Operating	-40...+125	$^\circ\text{C}$
T_{JM}		150	$^\circ\text{C}$
T_{stg}		-40...+125	$^\circ\text{C}$
V_{ISOL}	50/60 Hz, $t = 1\text{ min}$	2500	V~
	$I_{ISOL} \leq 1\text{ mA}, t = 1\text{ s}$	3000	V~
M_d	Mounting torque	2.7...3.3	Nm
d_s	Creep distance on surface	12.7	mm
d_A	Strike distance in air	9.6	mm
a	Maximum allowable acceleration	50	m/s^2
$R_{pin-chip}$		typ. 2	$\text{m}\Omega$
Weight	typ.	180	g

Features

- Soldering connections for PCB mounting
- Convenient package outline
- Thermistor
- UL registered, E 153432

Applications

- Drive Inverters with brake system

Advantages

- 2 functions in one package
- Easy to mount with two screws
- Suitable for wave soldering
- High temperature and power cycling capability

Data according to IEC 60747

Symbol	Conditions	Characteristic Values ($T_{VJ} = 25^{\circ}\text{C}$, unless otherwise specified)		
		min.	typ.	max.
Rectifier Diodes	I_R	$V_R = V_{RRM}, T_{VJ} = 25^{\circ}\text{C}$ $V_R = V_{RRM}, T_{VJ} = 150^{\circ}\text{C}$		0.1 mA 2 mA
	V_F	$I_F = 80\text{ A}, T_{VJ} = 25^{\circ}\text{C}$ $I_F = 150\text{ A}, T_{VJ} = 25^{\circ}\text{C}$	VUB 116 VUB 145	1.43 V 1.68 V
	V_{T0}	for power-loss calculations only	VUB 116 VUB 145	0.85 V 0.85 V
	r_T	$T_{VJ} = 150^{\circ}\text{C}$	VUB 116 VUB 145	7.1 m Ω 5.9 m Ω
	R_{thJC}	per diode	VUB 116 VUB 145	0.65 K/W 0.5 K/W
	R_{thCH}	per diode	VUB 116 VUB 145	0.1 K/W 0.1 K/W
	$V_{BR(CES)}$	$V_{GS} = 0\text{ V}, I_C = 0.1\text{ mA}$	1200	V
	$V_{GE(th)}$	$I_C = 8\text{ mA}$	VUB 116	4.5 V
		$I_C = 3\text{ mA}$	VUB 145	4.5 V
	I_{CES}	$T_{VJ} = 25^{\circ}\text{C}, V_{CE} = 1200\text{ V}$		0.1 mA
$T_{VJ} = 125^{\circ}\text{C}, V_{CE} = 0,8 \cdot V_{CES}$			0.5 mA	
V_{CEsat}	$V_{GE} = 15\text{ V}, I_C = 100\text{ A}$	VUB 116	3.5 V	
	$V_{GE} = 15\text{ V}, I_C = 150\text{ A}$	VUB 145	3.7 V	
$t_{SC}(\text{SCSOA})$	$V_{GE} = 15\text{ V}, V_{CE} = 720\text{ V}, T_{VJ} = 125^{\circ}\text{C}$,		10 μs	
RBSOA	$V_{GE} = 15\text{ V}, V_{CE} = 1200\text{ V}, T_{VJ} = 125^{\circ}\text{C}$, clamped inductive load, $L = 100\text{ }\mu\text{H}$			
	$R_G = 22\text{ }\Omega$	VUB 116	100 A	
	$R_G = 15\text{ }\Omega$	VUB 145	150 A	
C_{ies}	$V_{CE} = 25\text{ V}, f = 1\text{ MHz}, V_{GE} = 0\text{ V}$	VUB 116	3.8 nF	
		VUB 145	5.7 nF	
$t_{d(on)}$		VUB 116 VUB 145	150 ns 80 ns	
$t_{d(off)}$	$V_{CE} = 720\text{ V}, I_C = 50/75\text{ A}$		680 ns	
		$V_{GE} = 15\text{ V}, R_G = 22/15\text{ }\Omega$	VUB 116 VUB 145	6 mJ 9 mJ
E_{on}	Inductive load; $L = 100\text{ }\mu\text{H}$	VUB 116	9 mJ	
		VUB 145	4 mJ	
E_{off}	$T_{VJ} = 125^{\circ}\text{C}$	VUB 116	4 mJ	
		VUB 145	7.5 mJ	
R_{thJC}		VUB 116 VUB 145	0.33 K/W 0.22 K/W	
		VUB 116 VUB 145	0.66 K/W 0.44 K/W	
R_{thJH}		VUB 116 VUB 145	0.66 K/W 0.44 K/W	
		VUB 116 VUB 145	0.66 K/W 0.44 K/W	
Fast Recovery Diode	I_R	$V_R = V_{RRM}, T_{VJ} = 25^{\circ}\text{C}$ $V_R = 1200\text{ V}, T_{VJ} = 125^{\circ}\text{C}$	1	0.25 mA mA
	V_F	$I_F = 30\text{ A}, T_{VJ} = 25^{\circ}\text{C}$		2.76 V
	V_{T0}	For power-loss calculations only		1.3 V
	r_T	$T_{VJ} = 150^{\circ}\text{C}$		16 m Ω
	I_{RM}	$I_F = 50\text{ A}, -di_F/dt = 100\text{ A}/\mu\text{s}, V_R = 100\text{ V}$	5.5	11 A
	t_{rr}	$I_F = 1\text{ A}, -di_F/dt = 200\text{ A}/\mu\text{s}, V_R = 30\text{ V}$	40	ns
	R_{thJC}			0.9 K/W
				0.1 K/W
	R_{thCH}			0.9 K/W
				0.1 K/W
R_{25}		4.75	5.0 k Ω	
$B_{25/50}$			3375 K	

Dimensions in mm (1 mm = 0.0394")

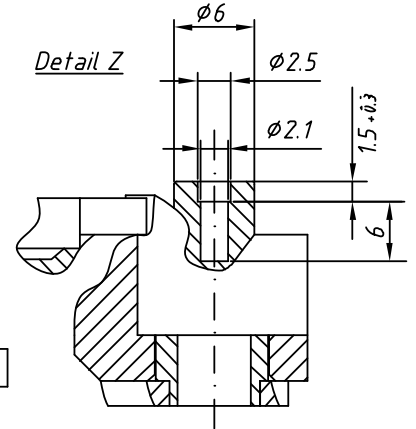
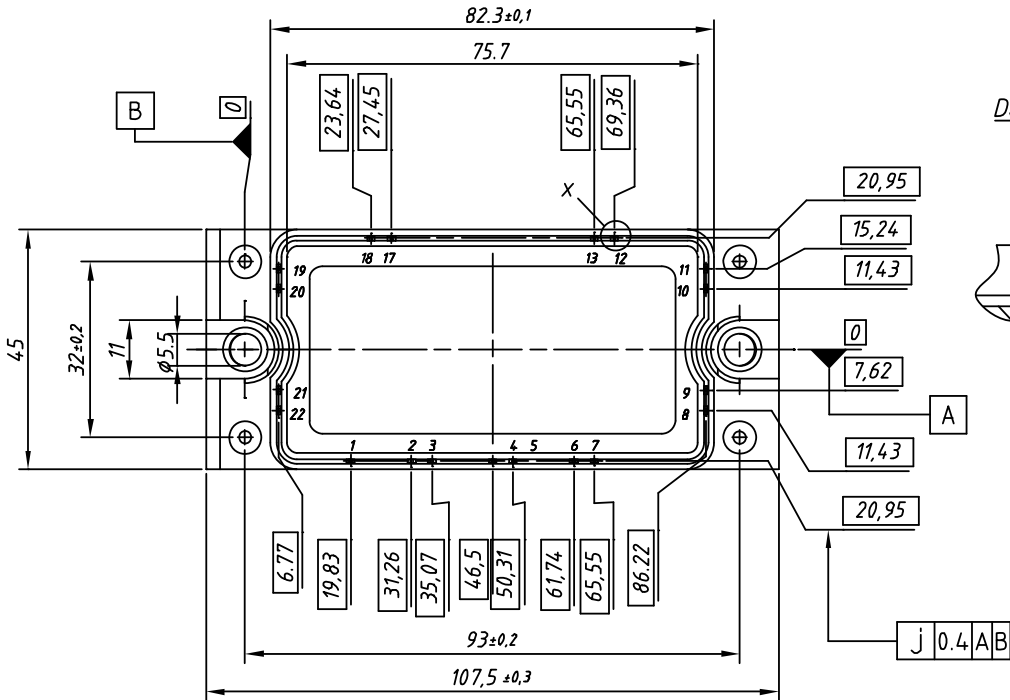
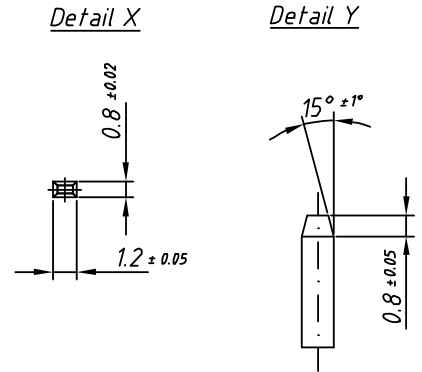
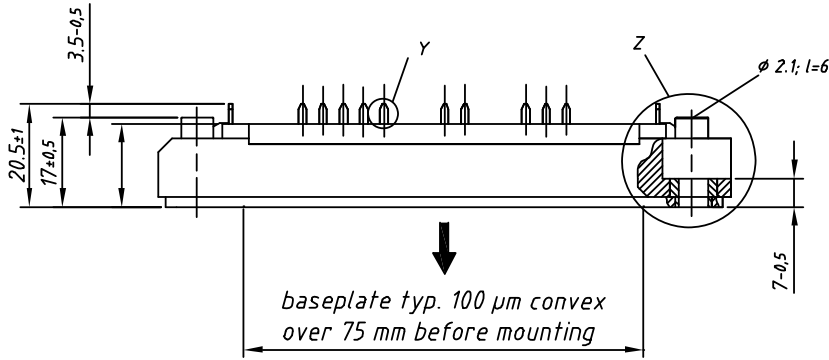

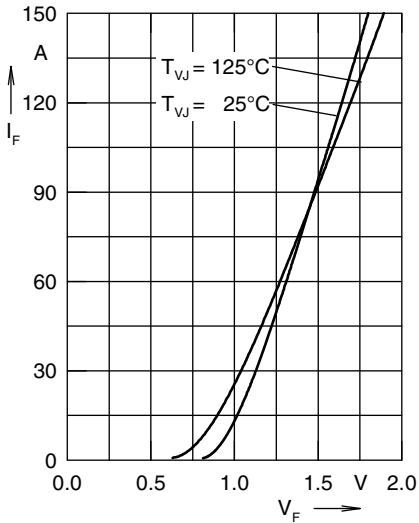

Fig. 1 Forward current vs. voltage drop per diode

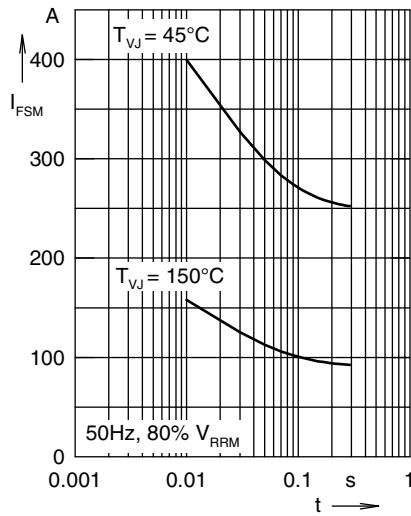

Fig. 2 Surge overload current

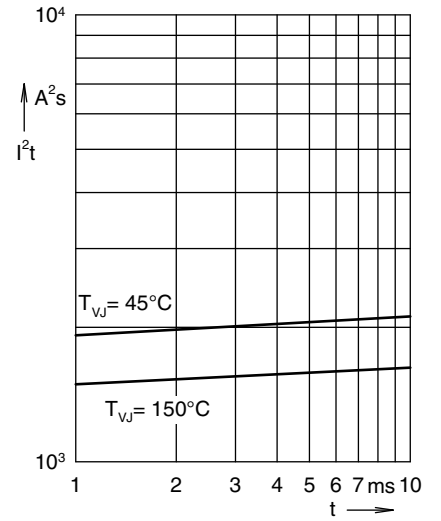

Fig. 3 I^2t versus time per diode

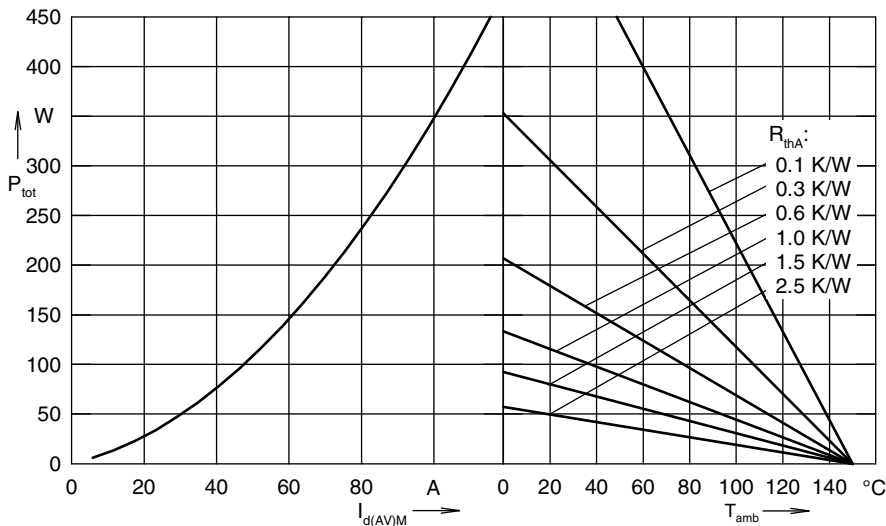

Fig. 4 Power dissipation versus direct output current and ambient temperature, sine 180°

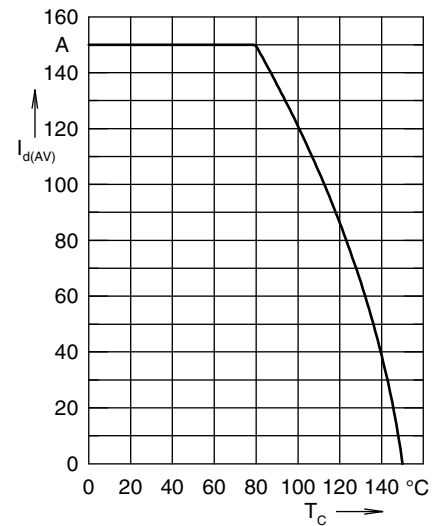

Fig. 5 Max. forward current vs. case temperature

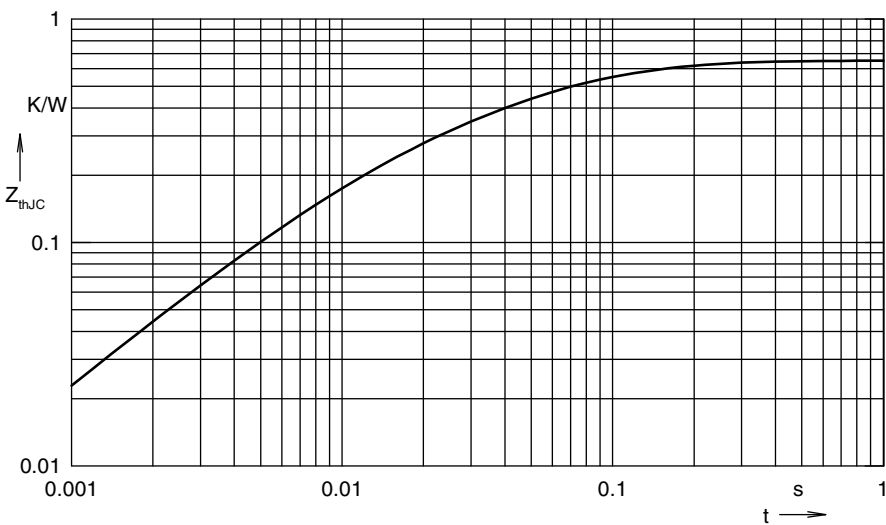

Fig. 6 Transient thermal impedance junction to case

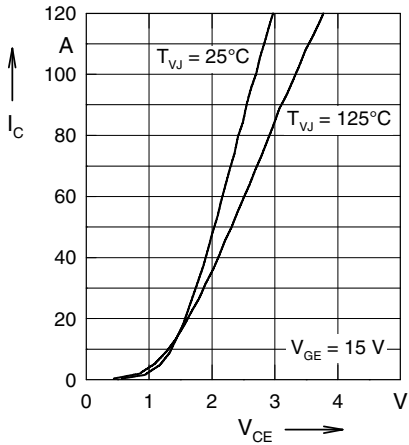

Fig. 7 Typ. output characteristics

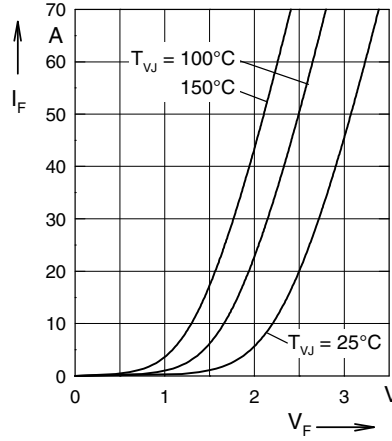

Fig. 8 Typ. forward characteristics of free wheeling diode

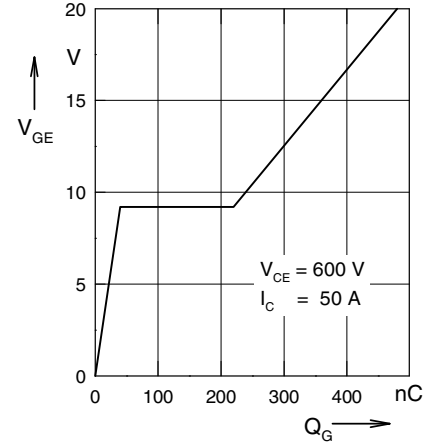

Fig. 9 Typ. turn on gate charge

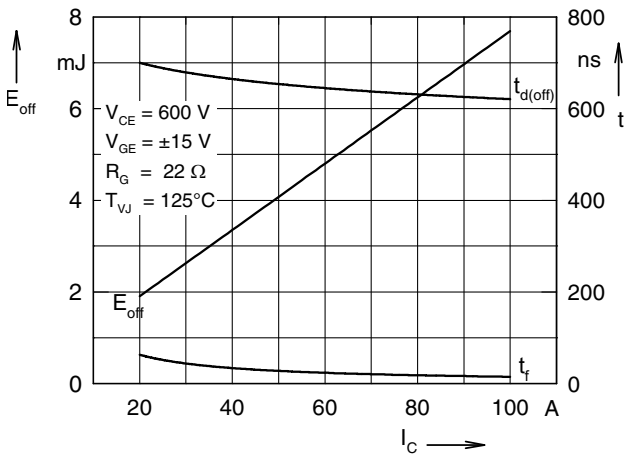

Fig. 10 Typ. turn off energy and switching times versus collector current

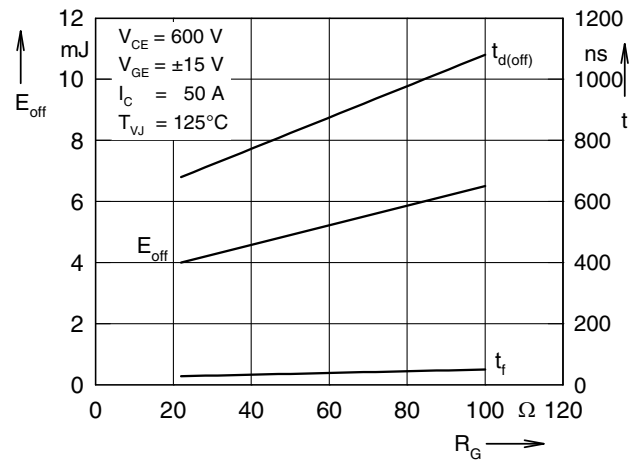

Fig. 11 Typ. turn off energy and switching times versus gate resistor

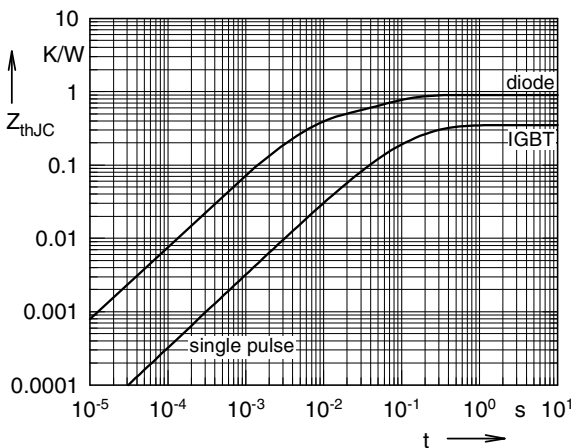

Fig. 12 Typ. transient thermal impedance

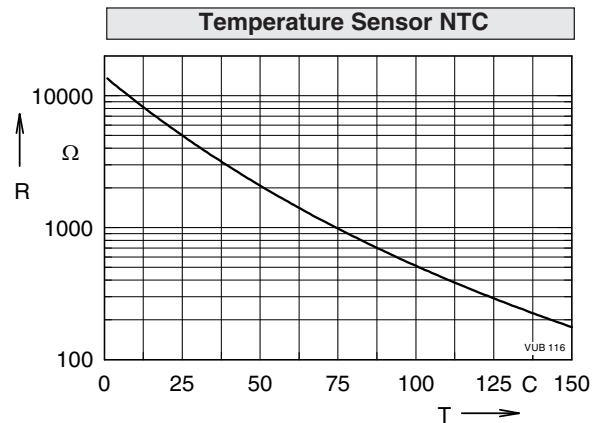

Fig. 13 Typ. thermistor resistance versus temperature

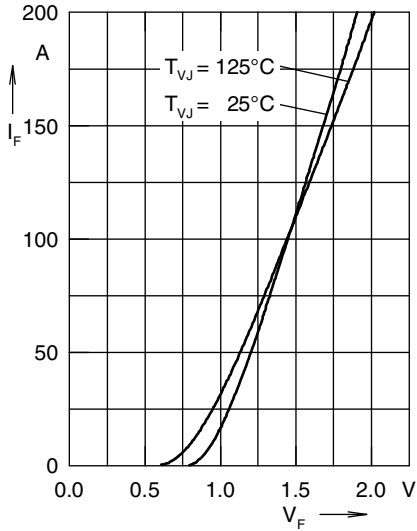

Fig. 1 Forward current versus voltage drop per diode

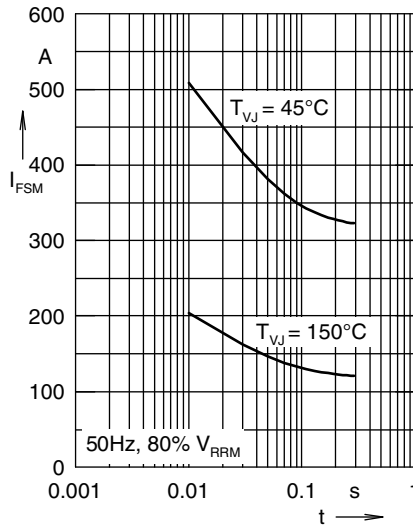

Fig. 2 Surge overload current

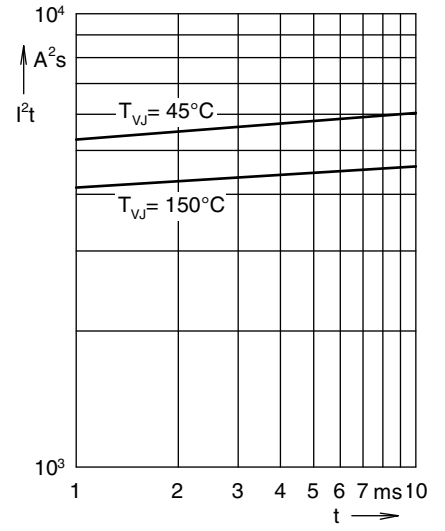

Fig. 3 I²t versus time per diode

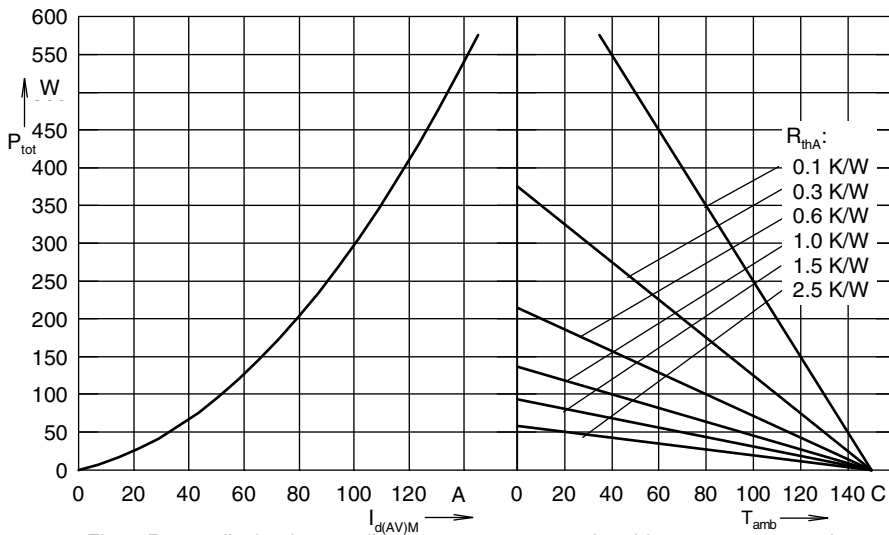

Fig. 4 Power dissipation vs. direct output current and ambient temperature, sin 180°

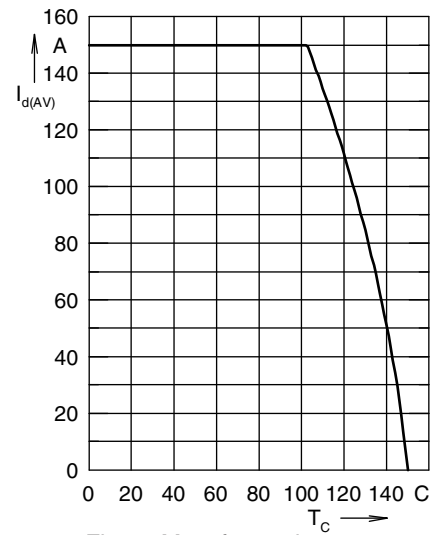

Fig. 5 Max. forward current vs. case temperature

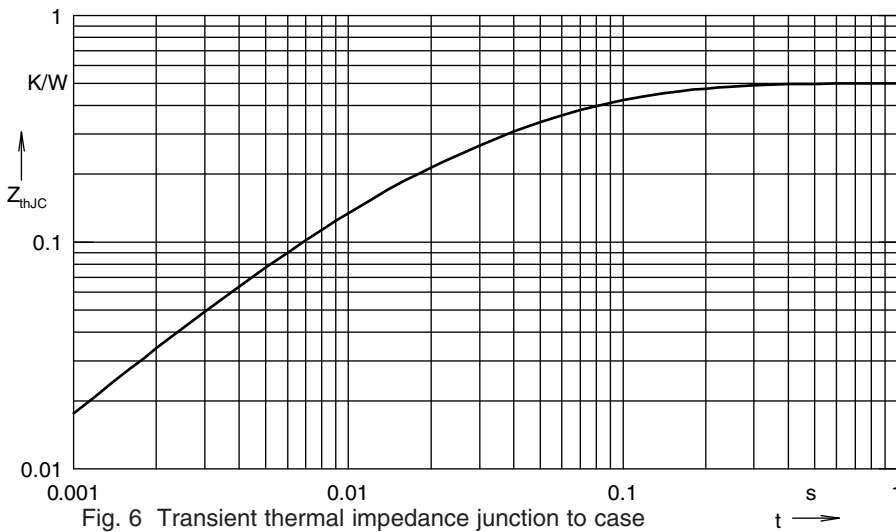

Fig. 6 Transient thermal impedance junction to case

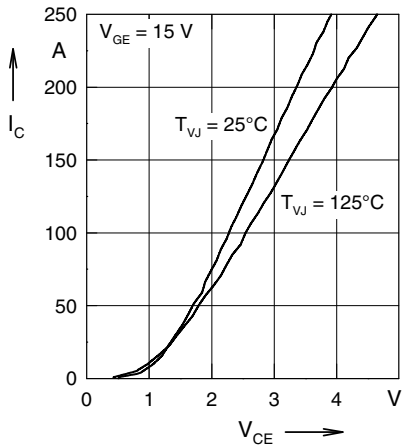

Fig. 7 Typ. output characteristics

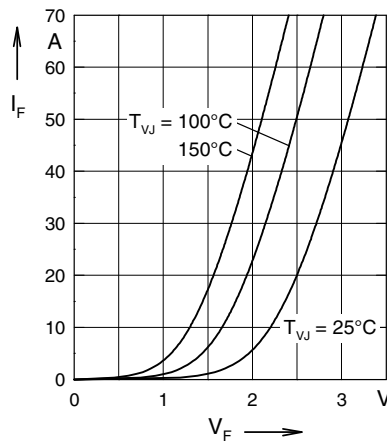

Fig. 8 Typ. forward characteristics of free wheeling diode

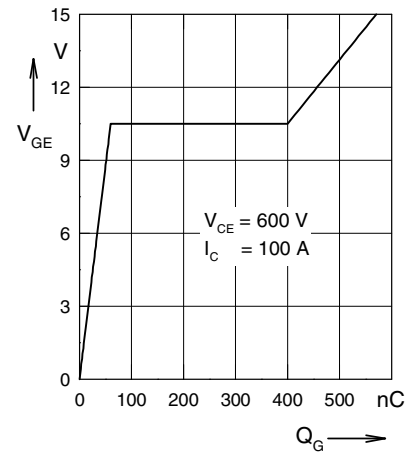

Fig. 9 Typ. turn on gate charge

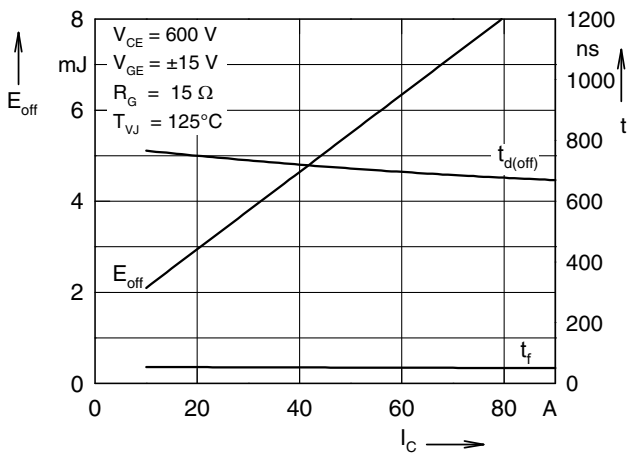

Fig. 10 Typ. turn off energy and switching times versus collector current

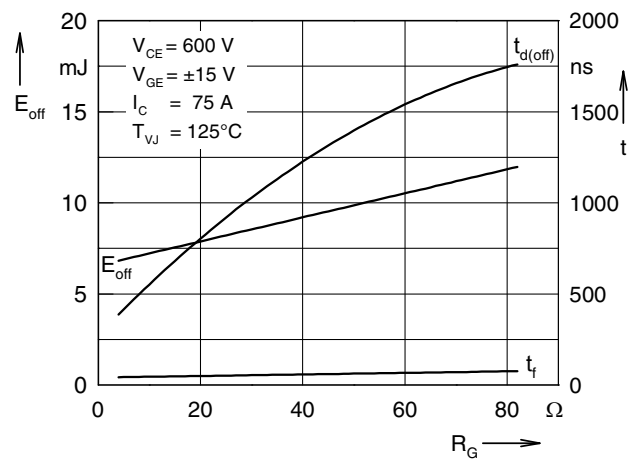

Fig. 11 Typ. turn off energy and switching times versus gate resistor

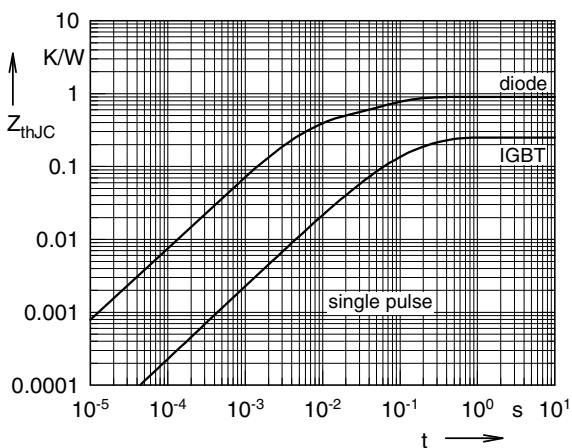

Fig. 12 Typ. transient thermal impedance

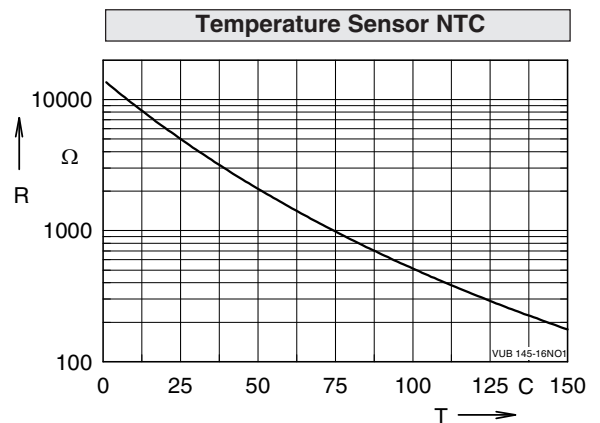

Fig. 13 Typ. thermistor resistance versus temperature